



New Zealand Kennel Club

AGILITY DOG EXCELLENT ADVANCED TRIALS

Course Plans

2009 Revision, effective from 1 January 2010

NZKC ADX ADVANCED TRIALS ~ COURSES ~ LEGEND

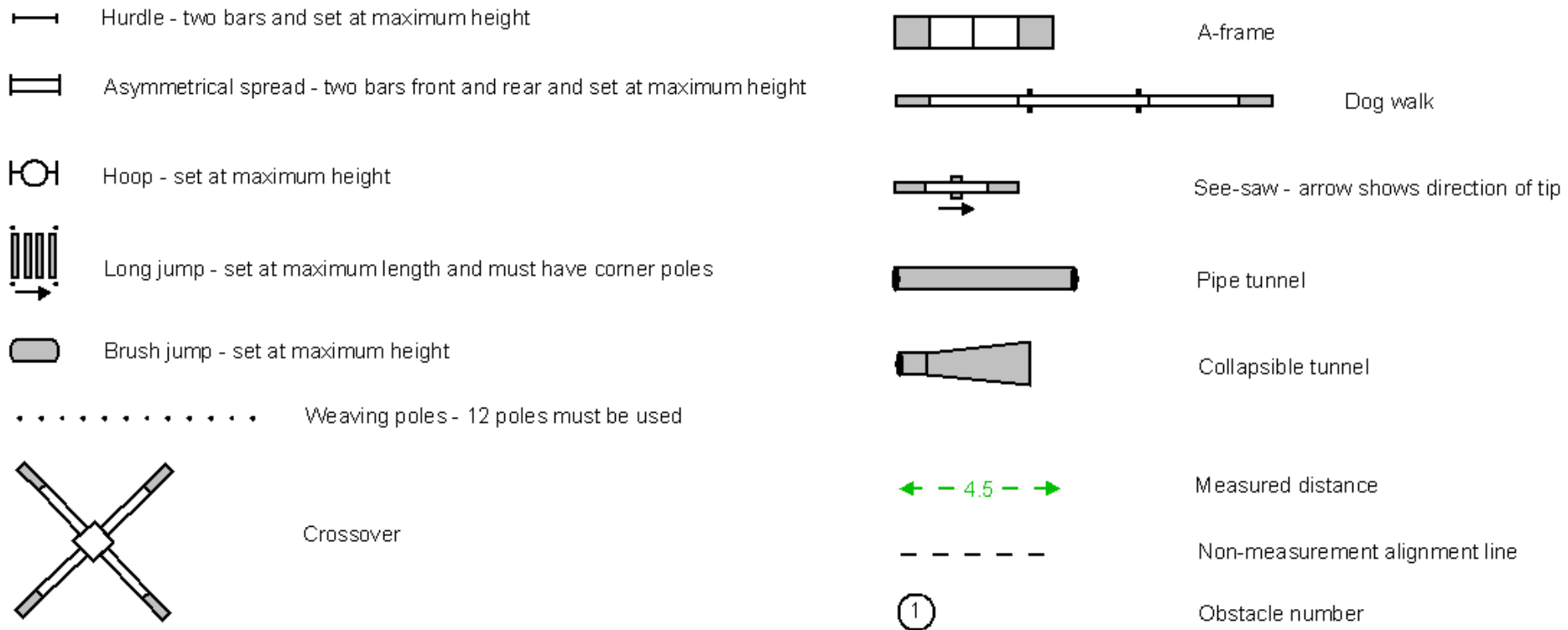

Electronic Timing should be used where possible. If hand-held timing is utilised, timing must still be taken from first and last obstacle as shown on the plan.

The course is to be measured for length following the path the handler would take if they were to run the course with the dog on their left hand side throughout (a guide is included for each course plan). Individual measurements should be as close as possible to that given, however a plus or minus variance of 0.25 metre is acceptable.

Courses should be randomly drawn, with a re-draw allowable if the drawn course is not suitable for the layout of the ring which will be used.

Assembly area

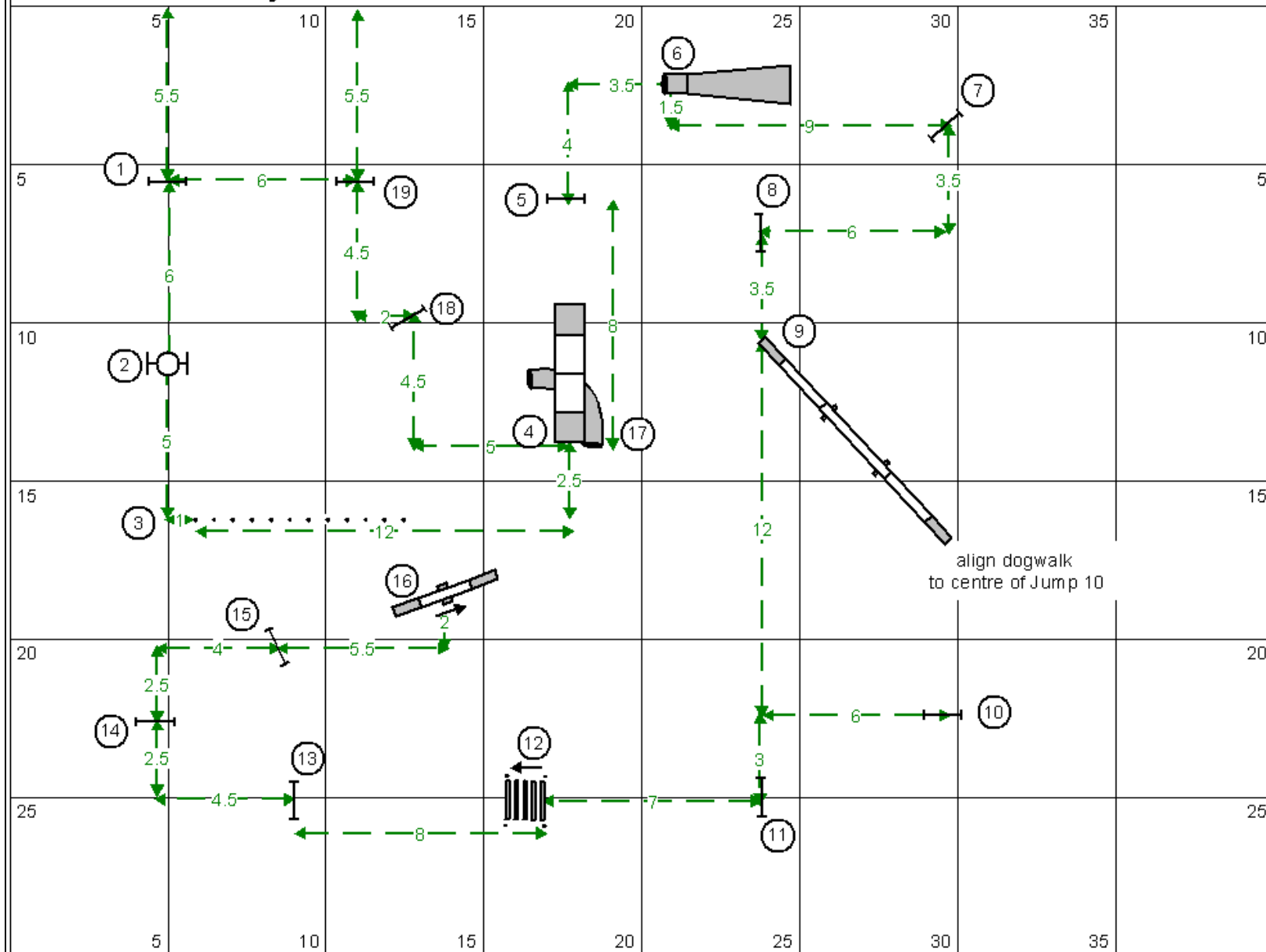

Assembly area

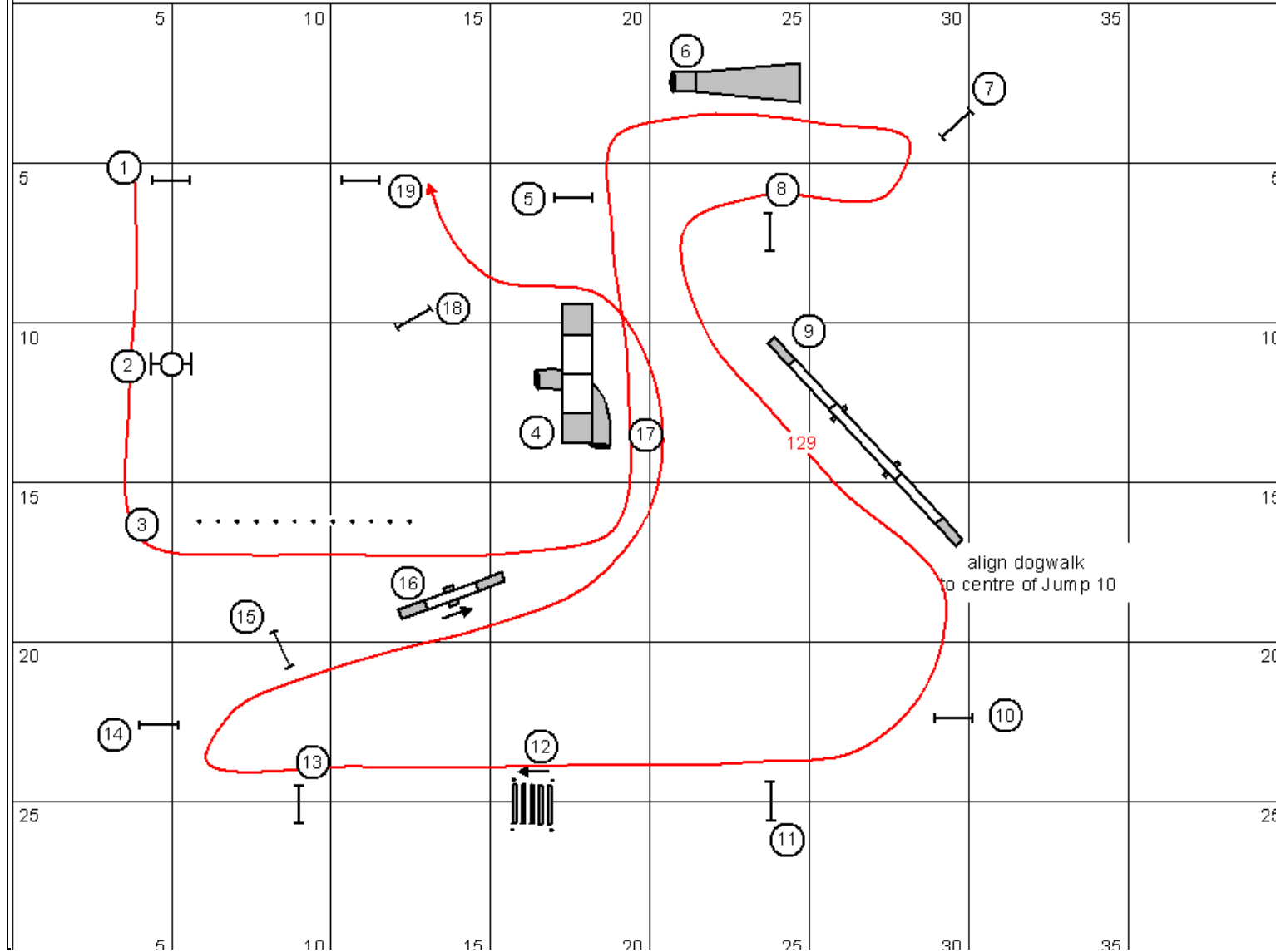

ADX Advanced course number 1 - course measurement guide

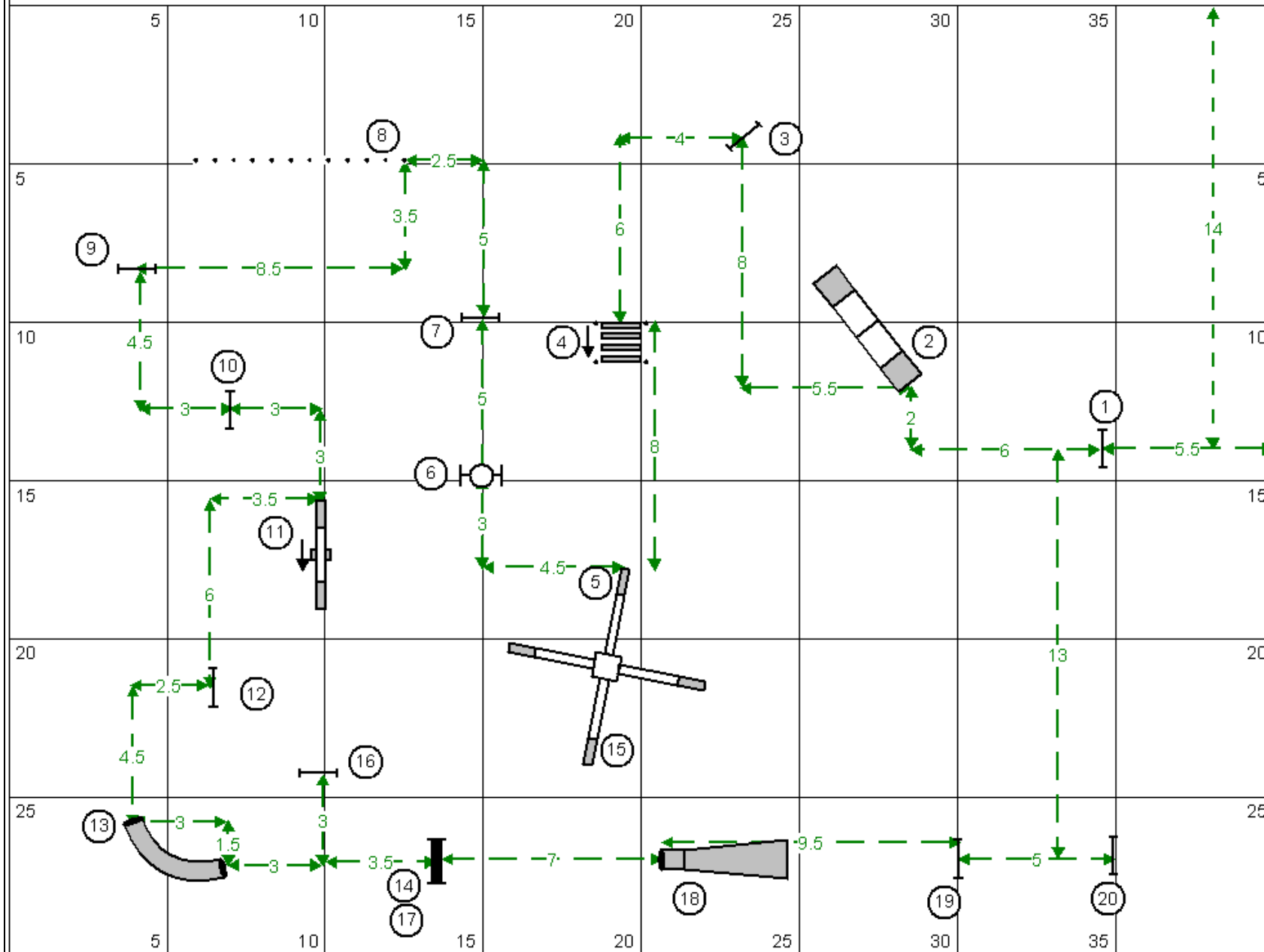

A
s
s
e
m
b
l
y

a
r
e
a

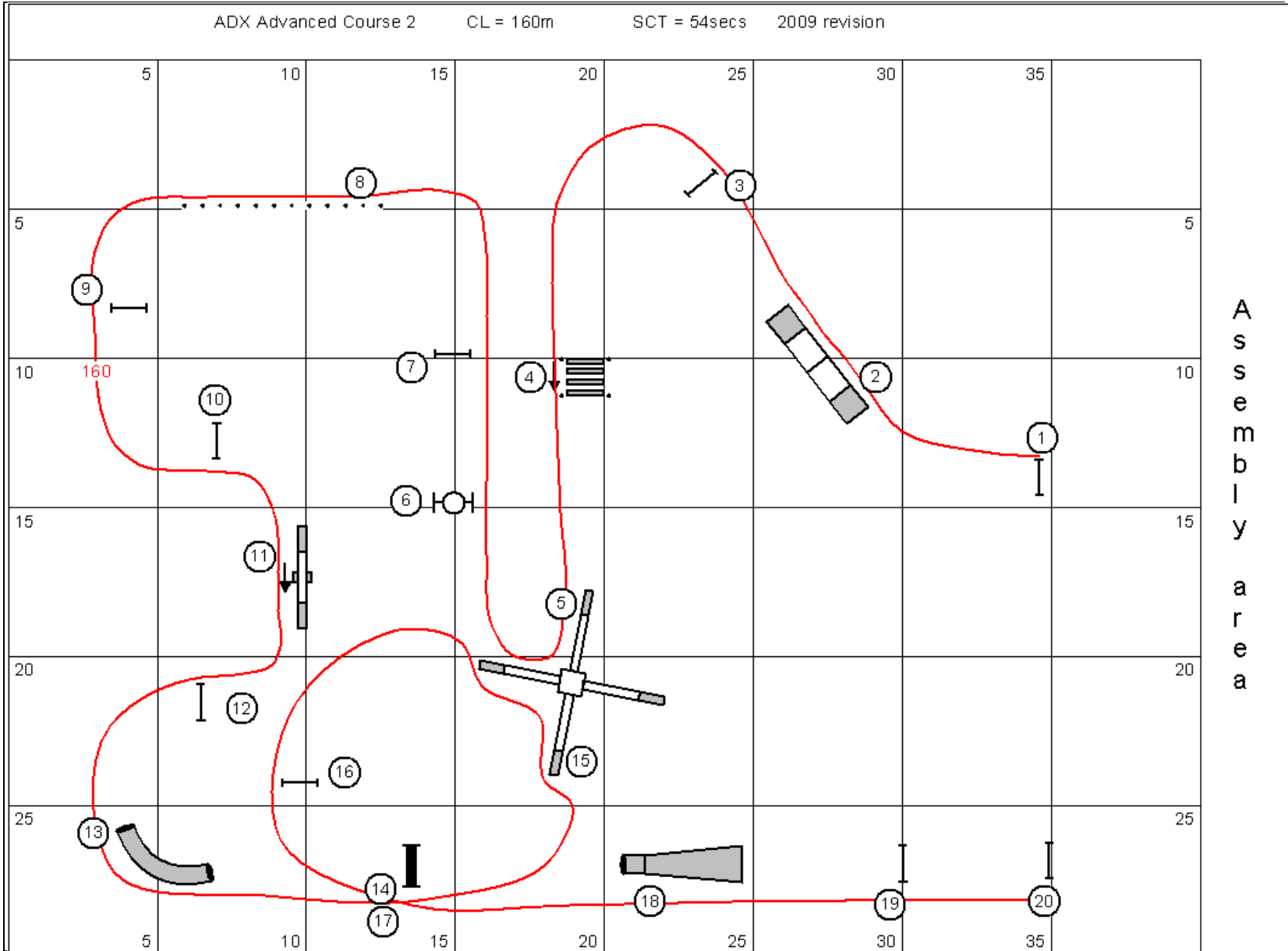

ADX Advanced course number 2 - course measurement guide

ADX Advanced course 3

CL = 156m

SCT = 52 secs

2009 revision

A
s
s
e
m
b
l
y

A
r
e
a

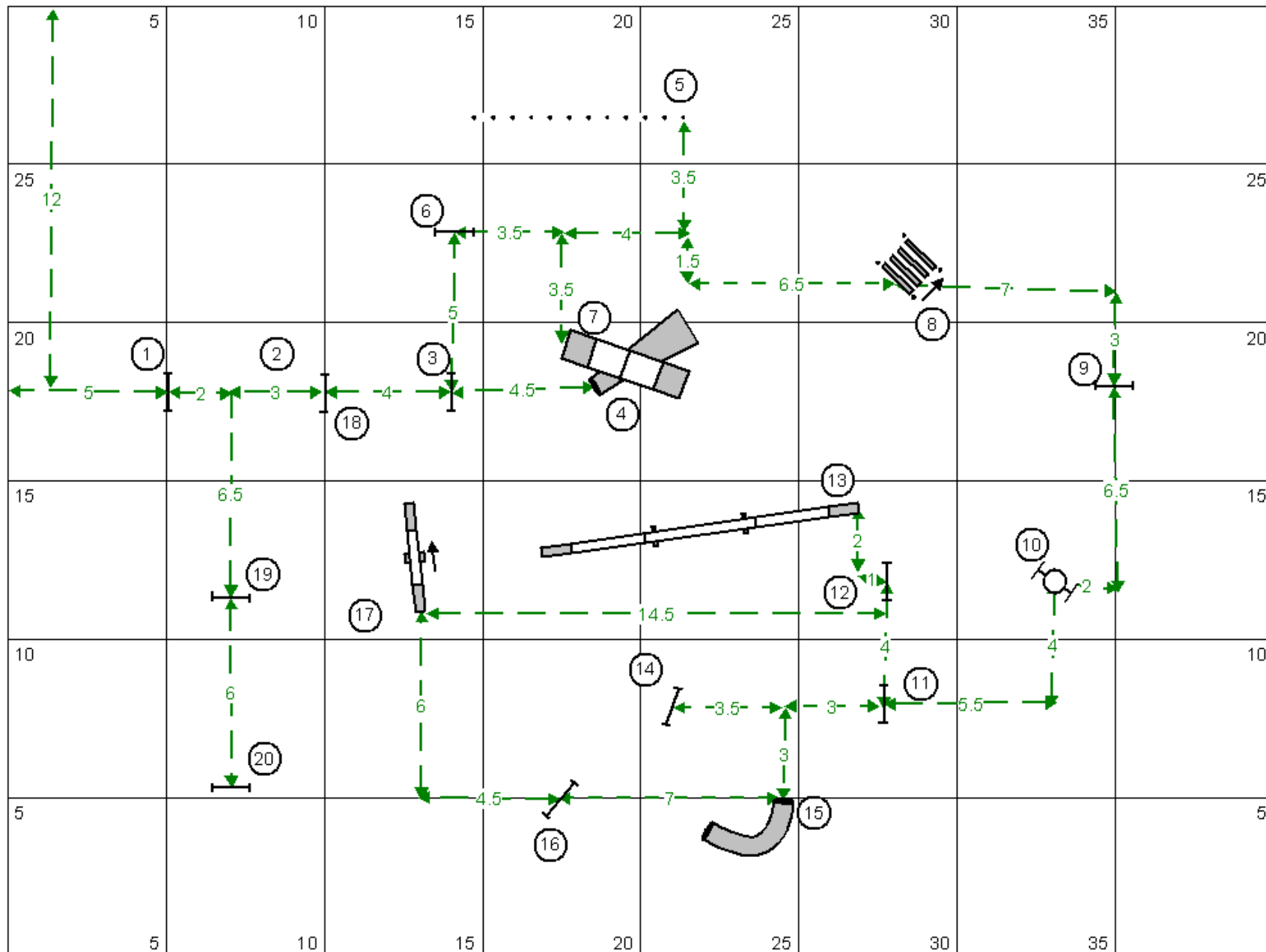

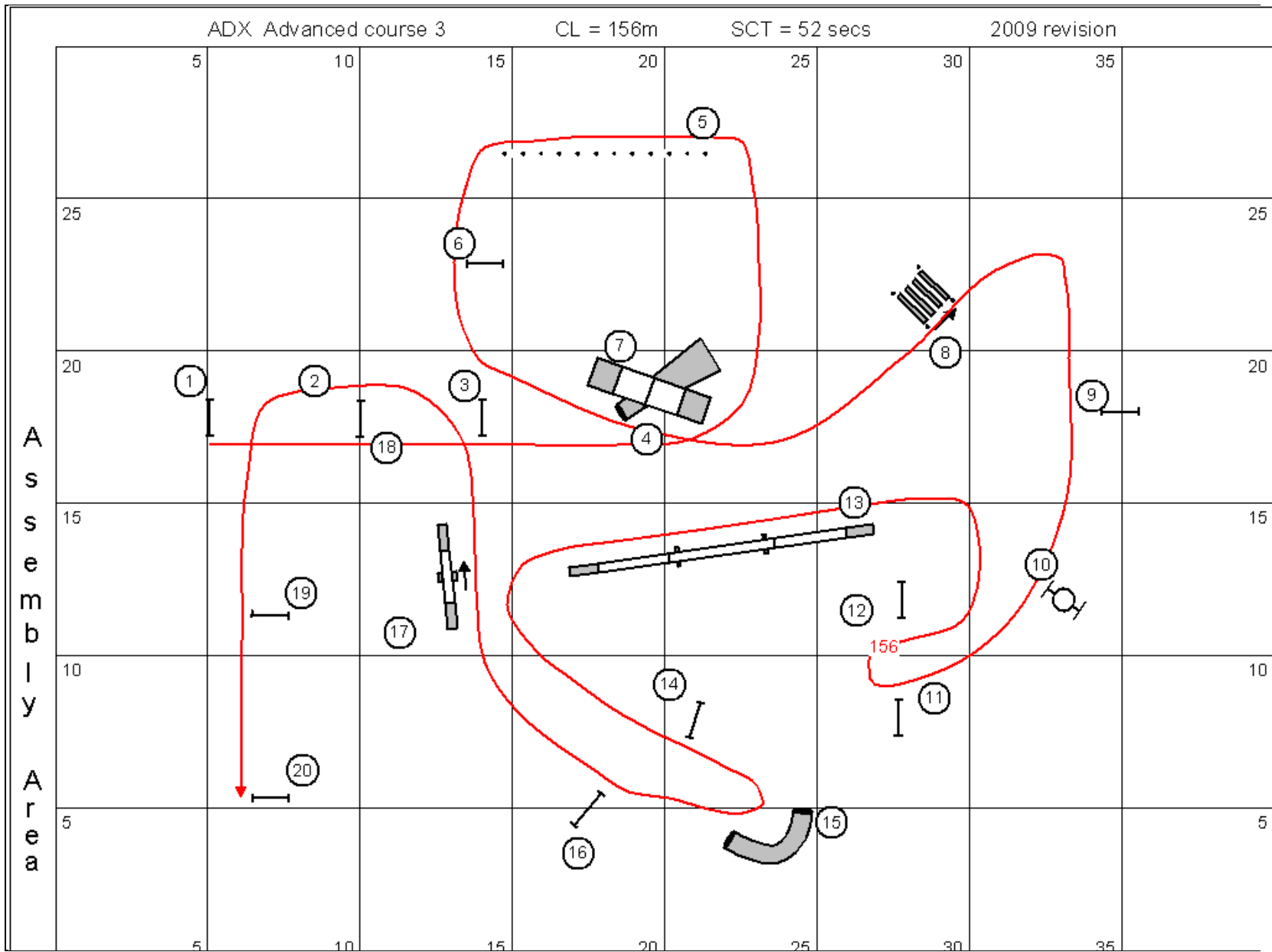

ADX Advanced course number 3 - course measurement guide

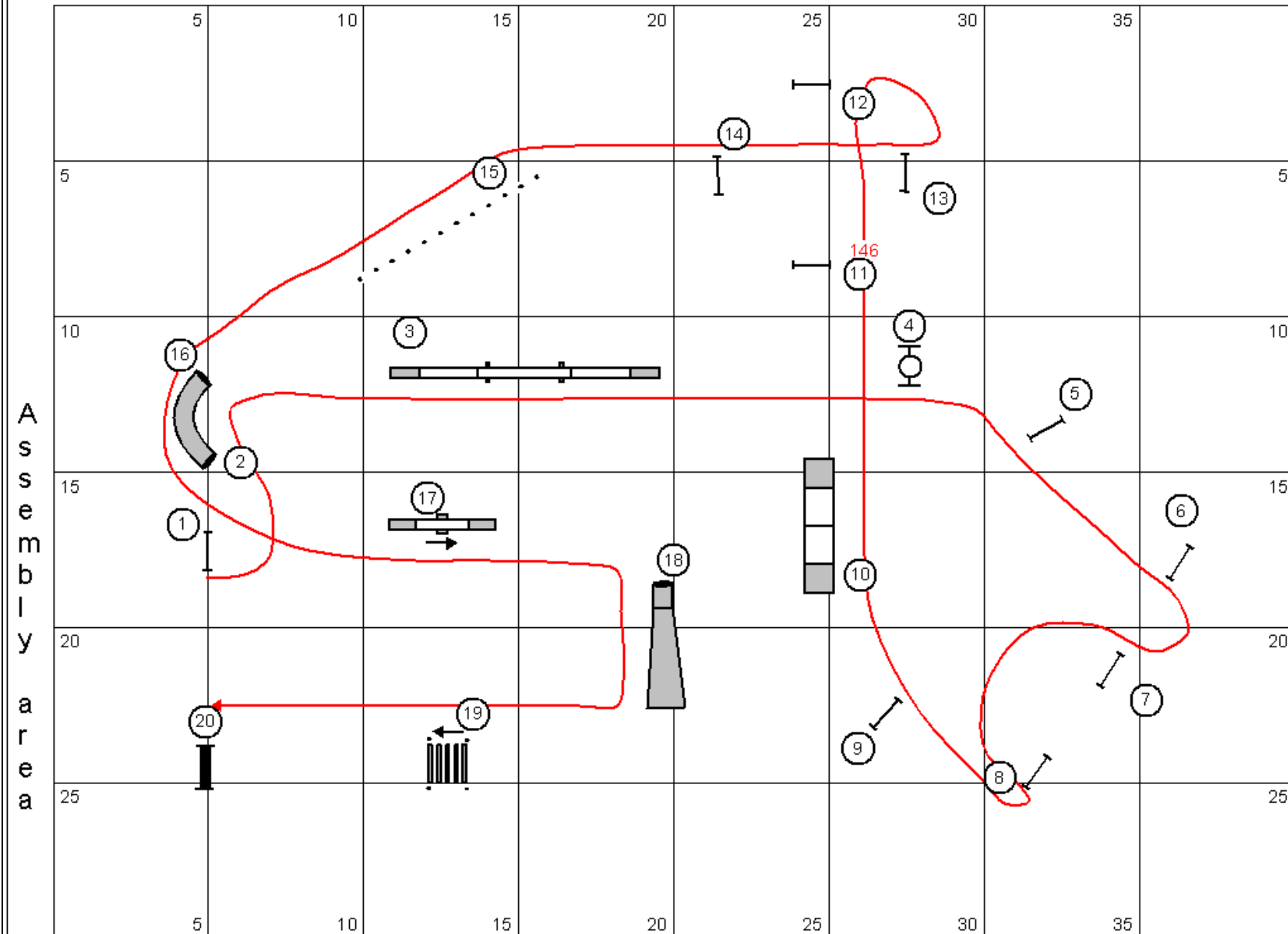

ADX Advanced course number 4 - course measurement guide

ADX Advanced course 6

CL = 146m

SCT = 49 secs

2009 Revision

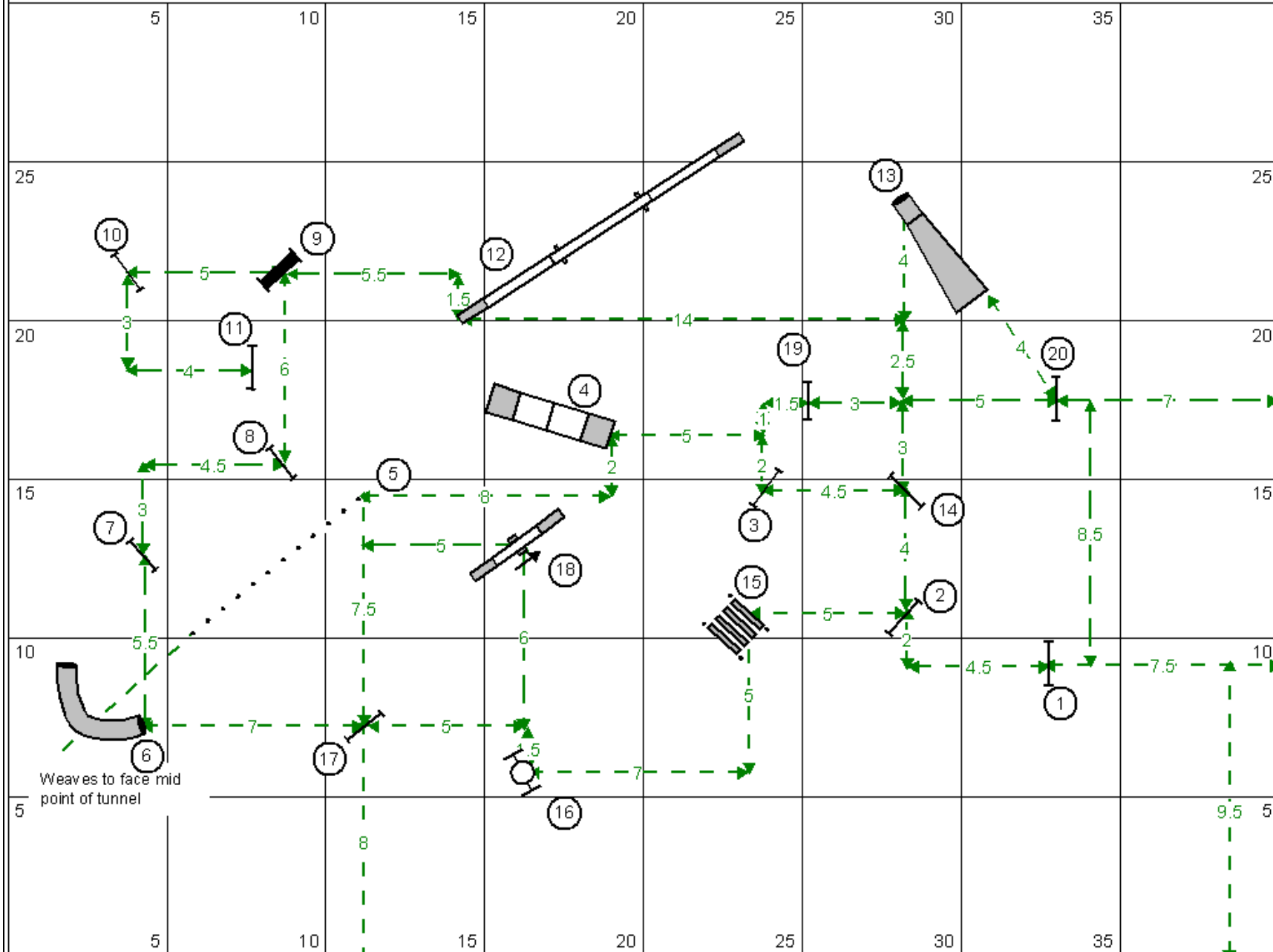

Assembly area

Weaves to face mid point of tunnel

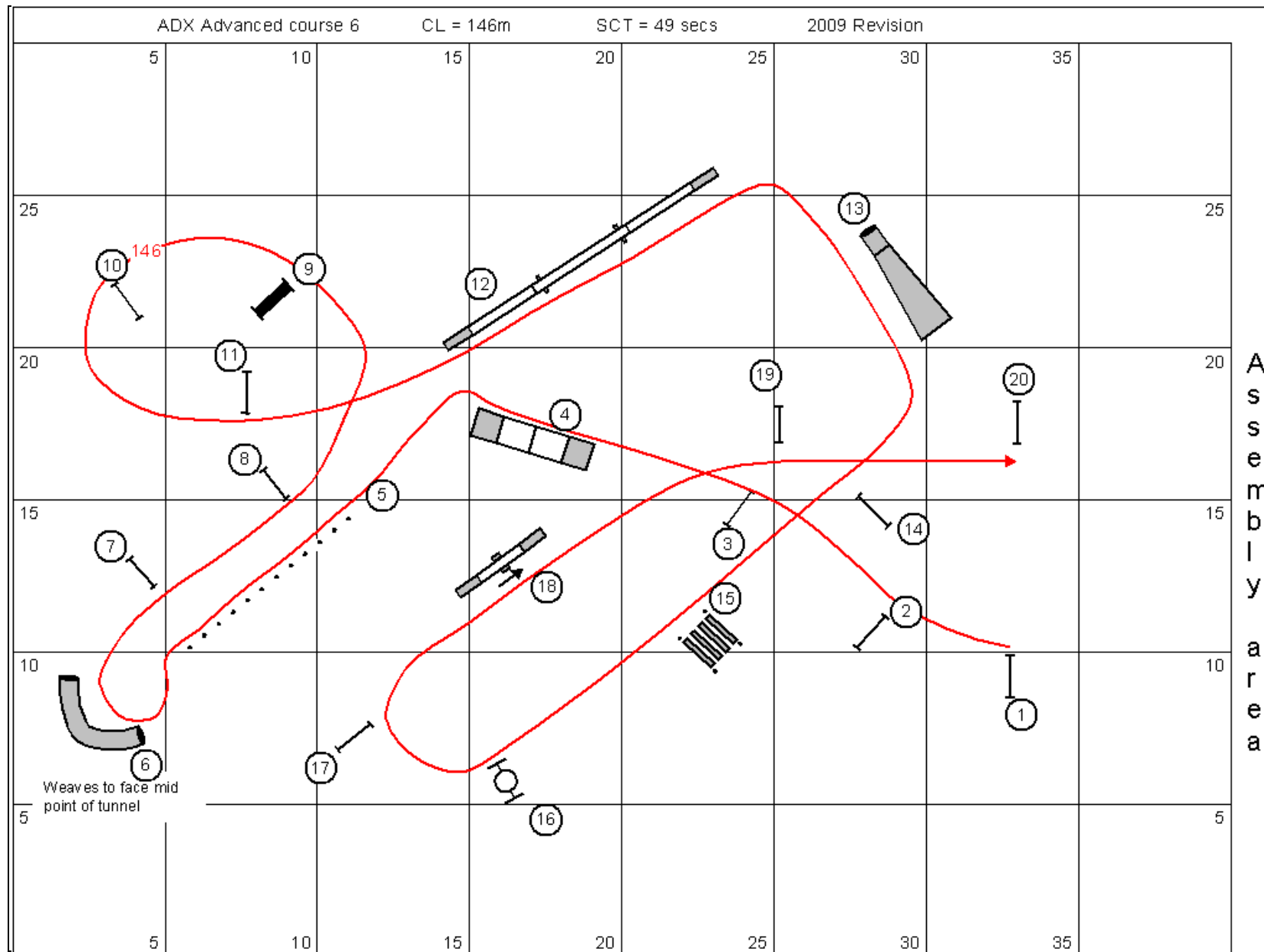

ADX Advanced course number 6 - course measurement guide

ADX Advanced course 7

CL = 165 m

SCT = 55 secs

2009 revision

Assembly area

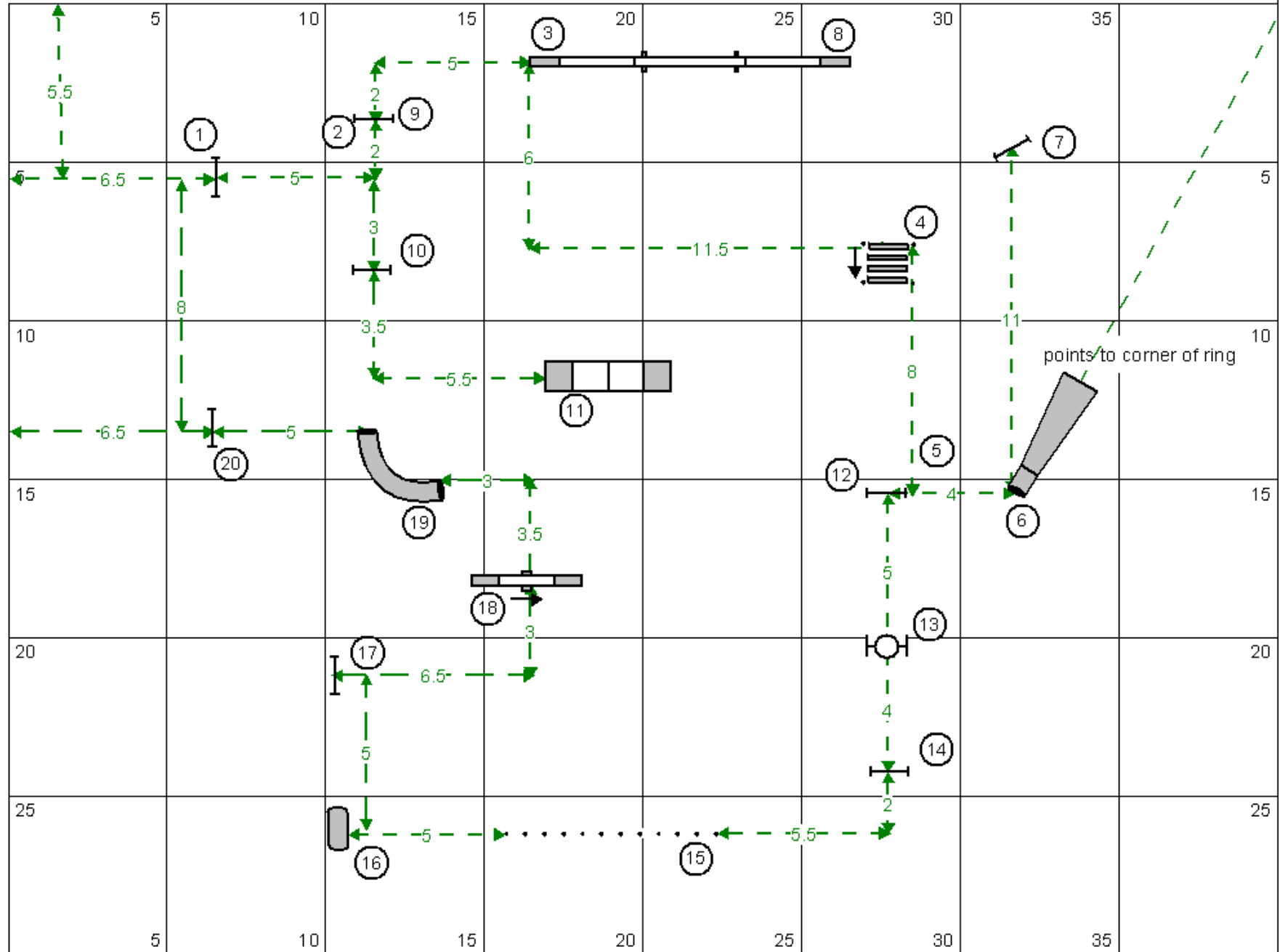

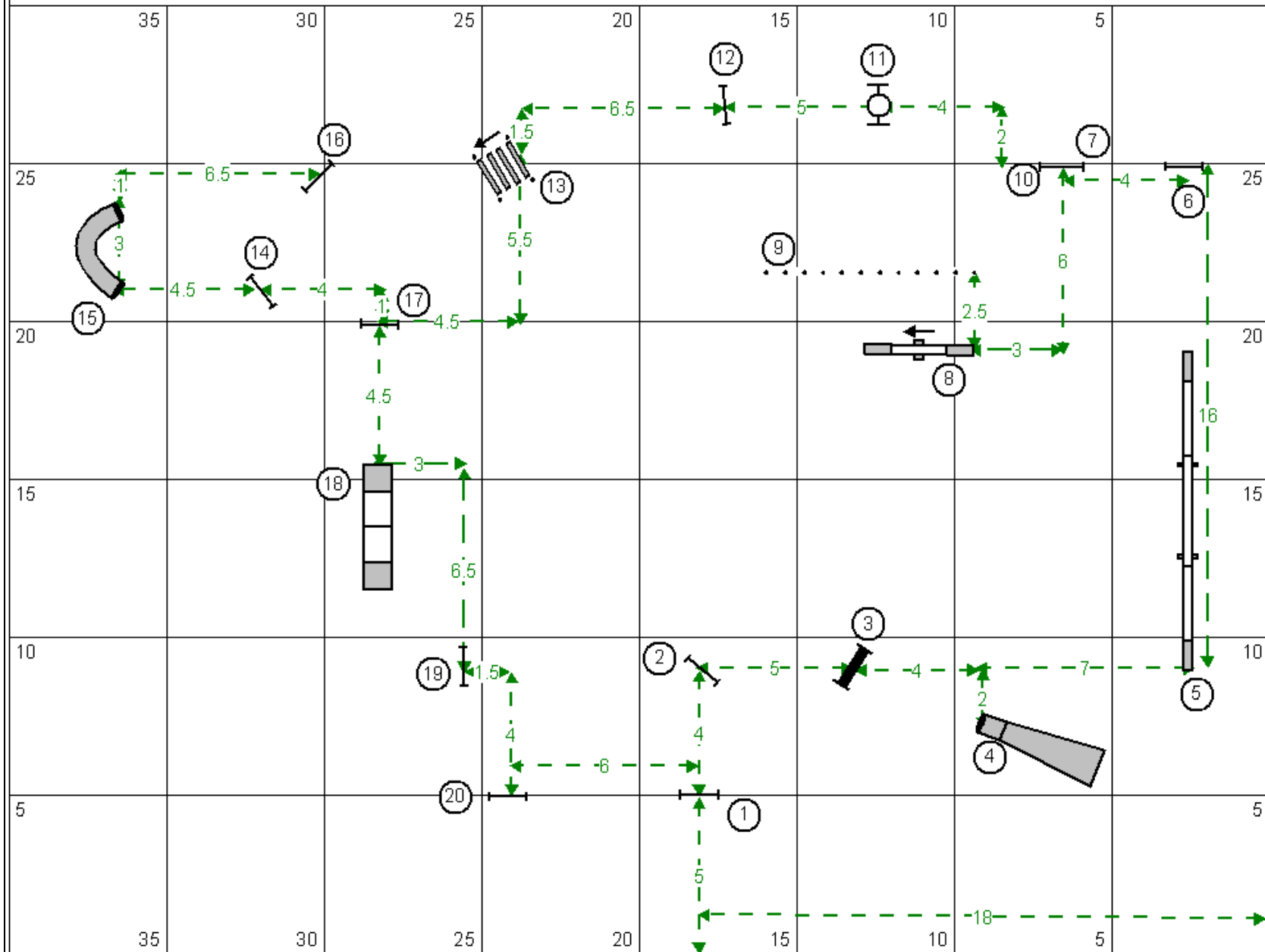

Assembly area

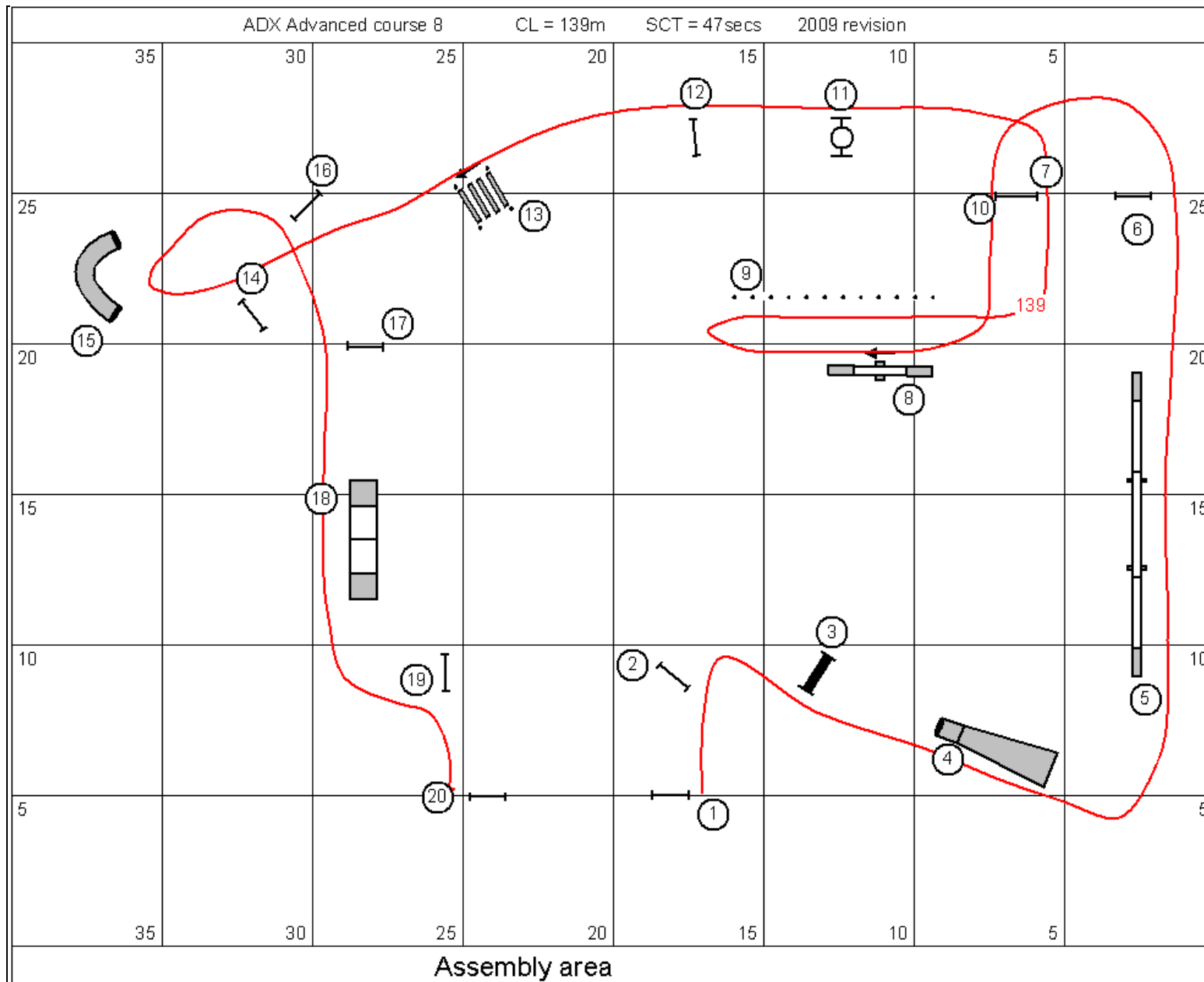

ADX Advanced course number 8 - course measurement guide

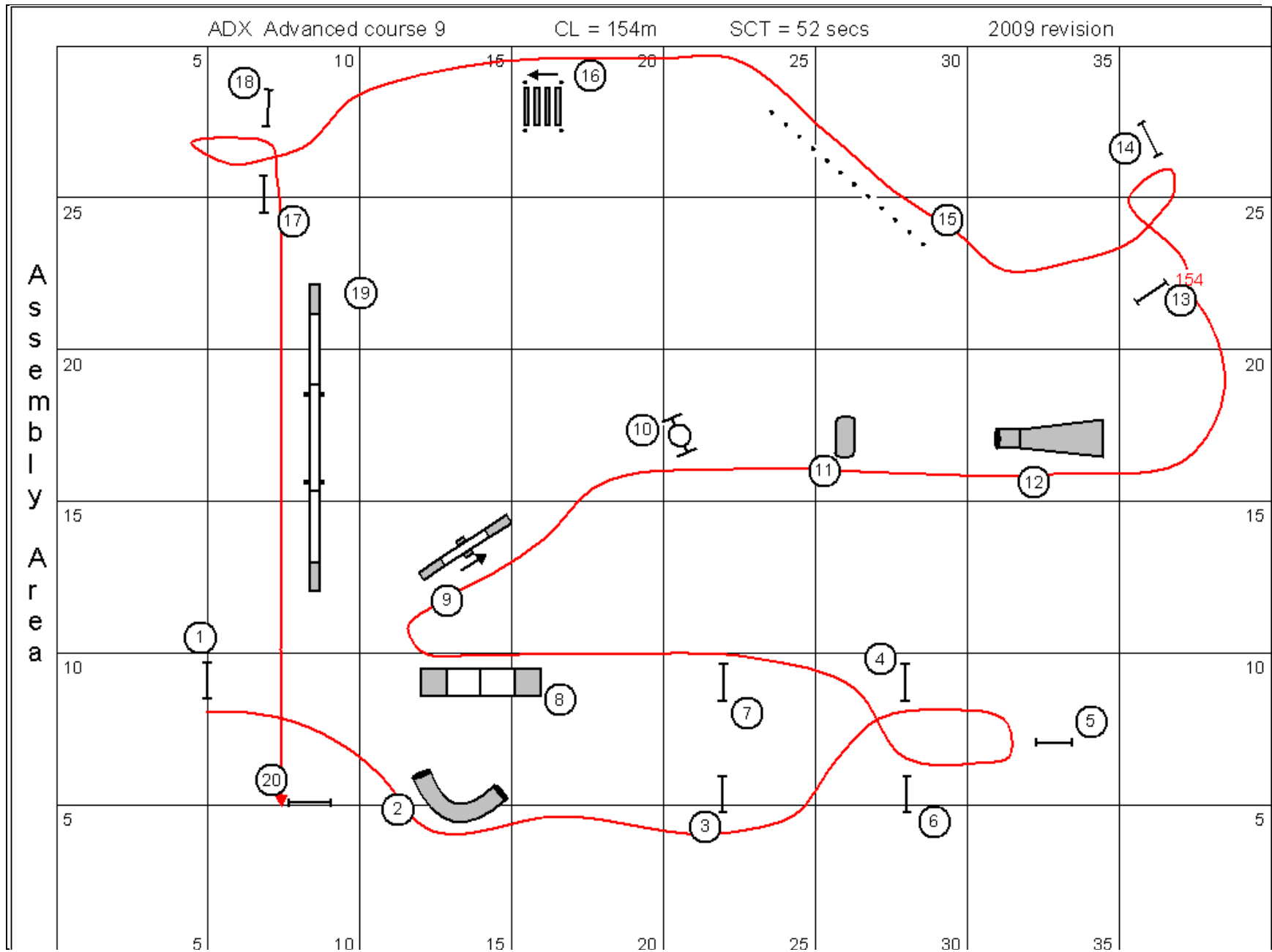

ADX Advanced course 10

CL = 148m

SCT = 50 secs

2009 revision

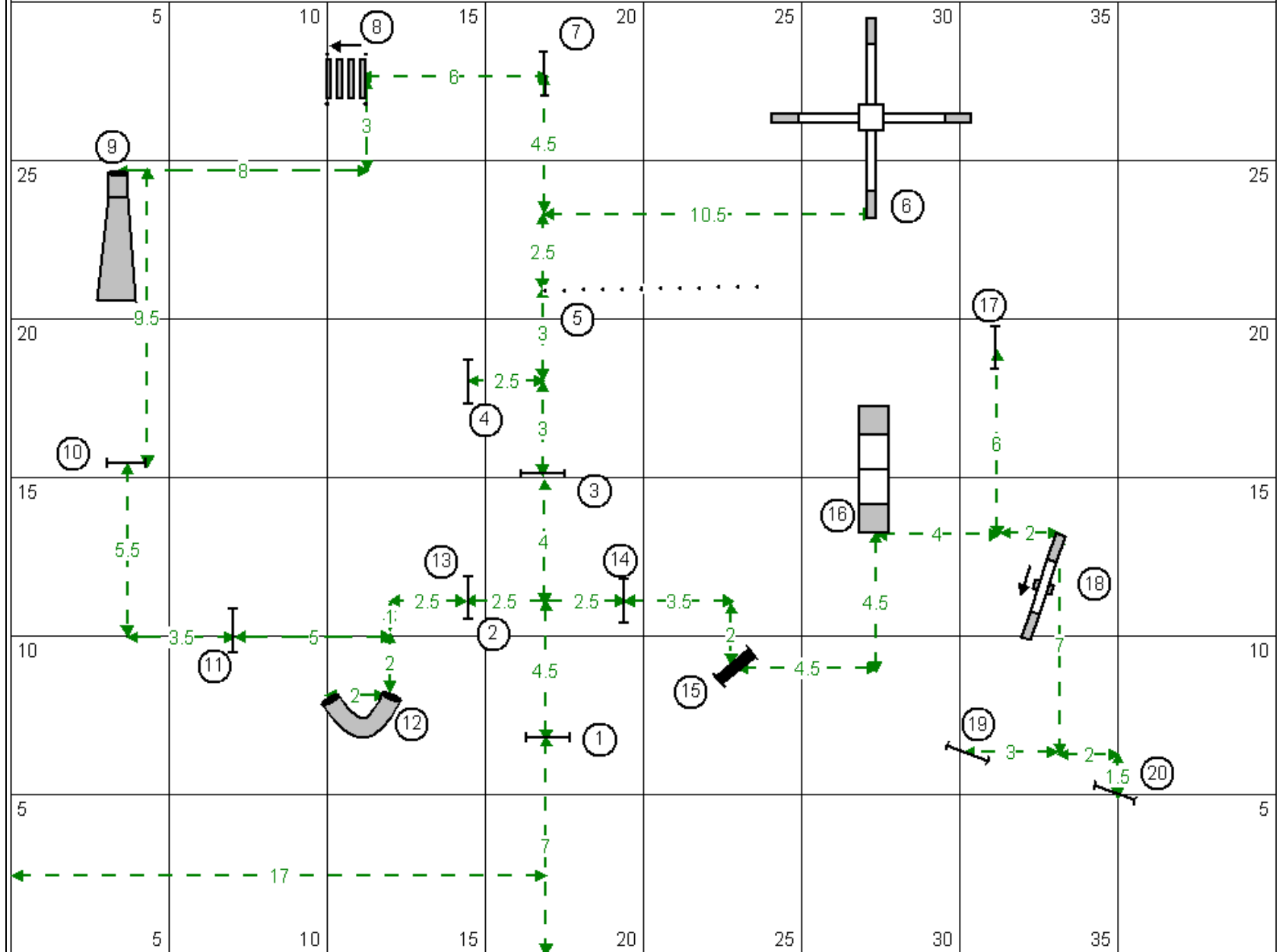

Assembly area

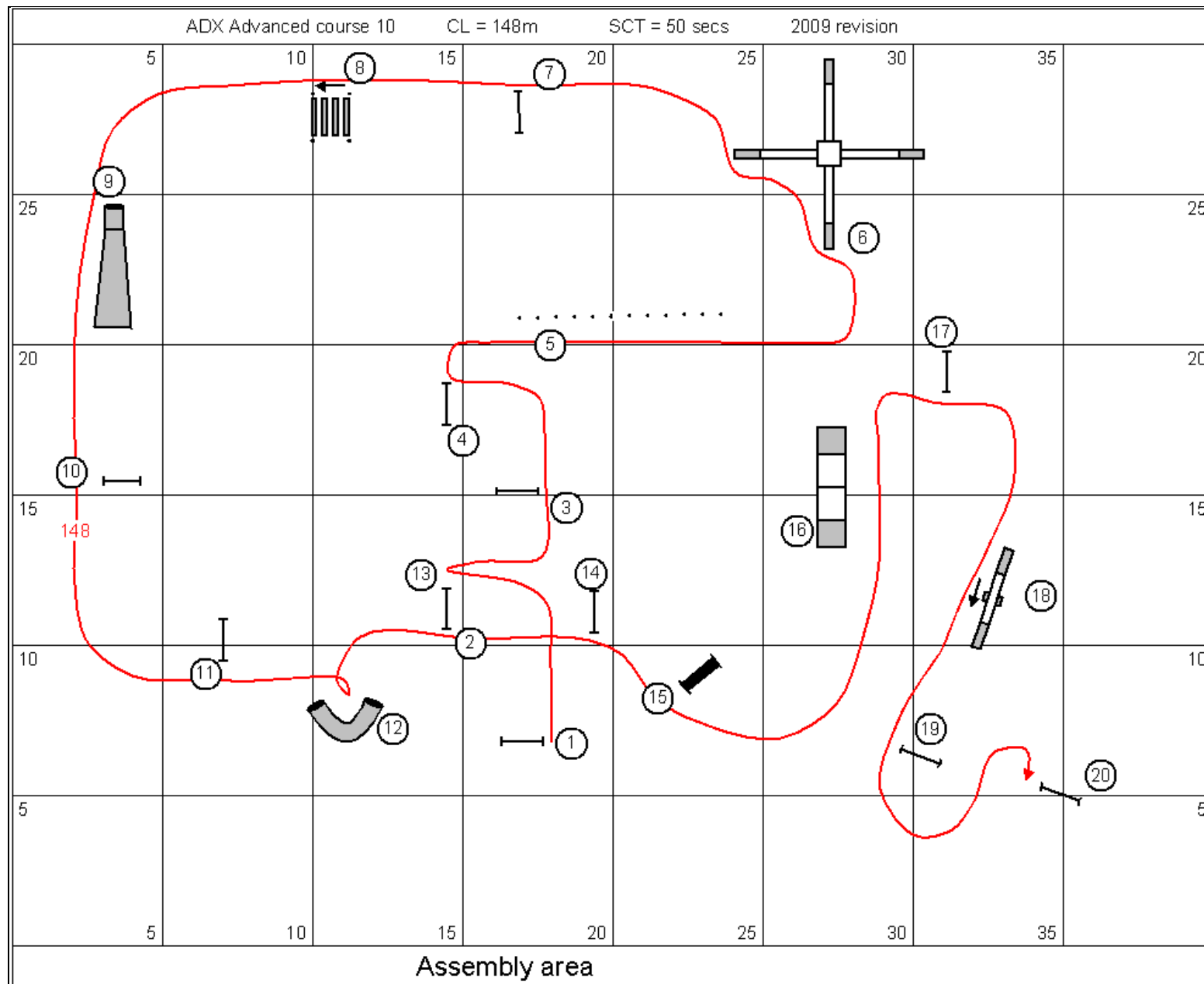

ADX Advanced course number 10 - course measurement guide

A
s
s
e
m
b
l
y

a
r
e
a

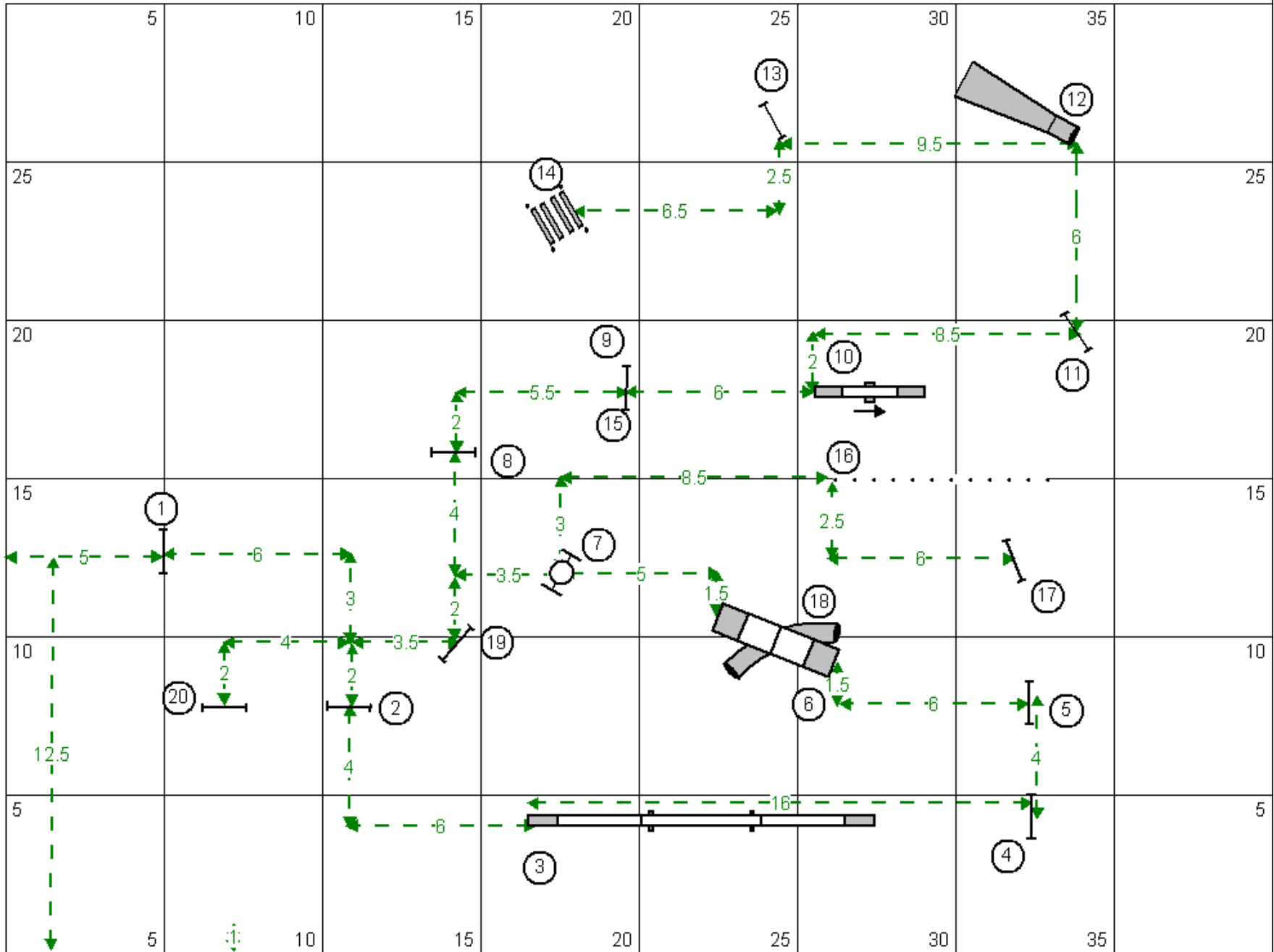

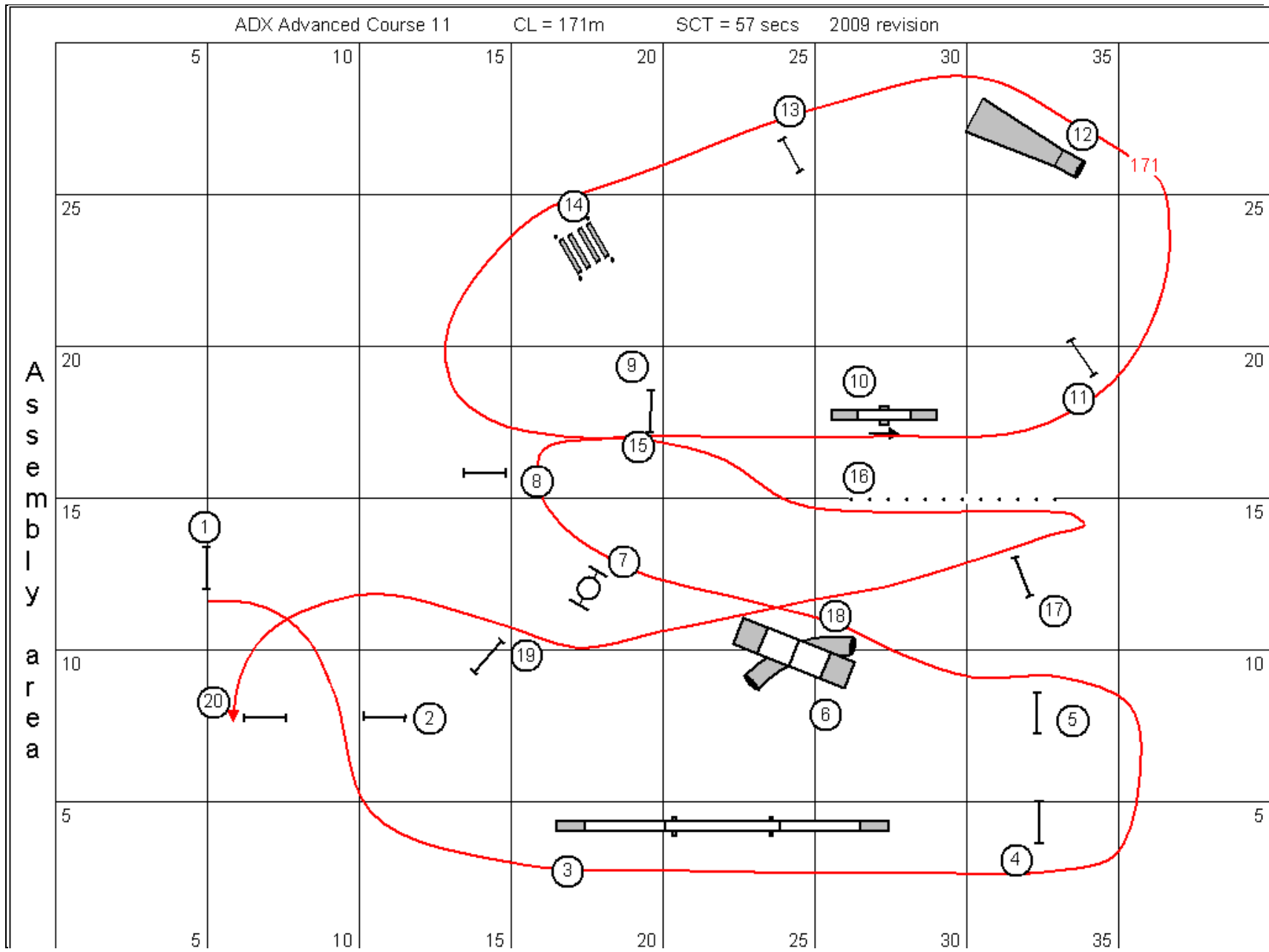

ADX Advanced course number 11 - course measurement guide

ADX Advanced course 12

CL 162m

SCT = 54 secs

2009 revision

A
s
s
e
m
b
l
y

A
r
e
a

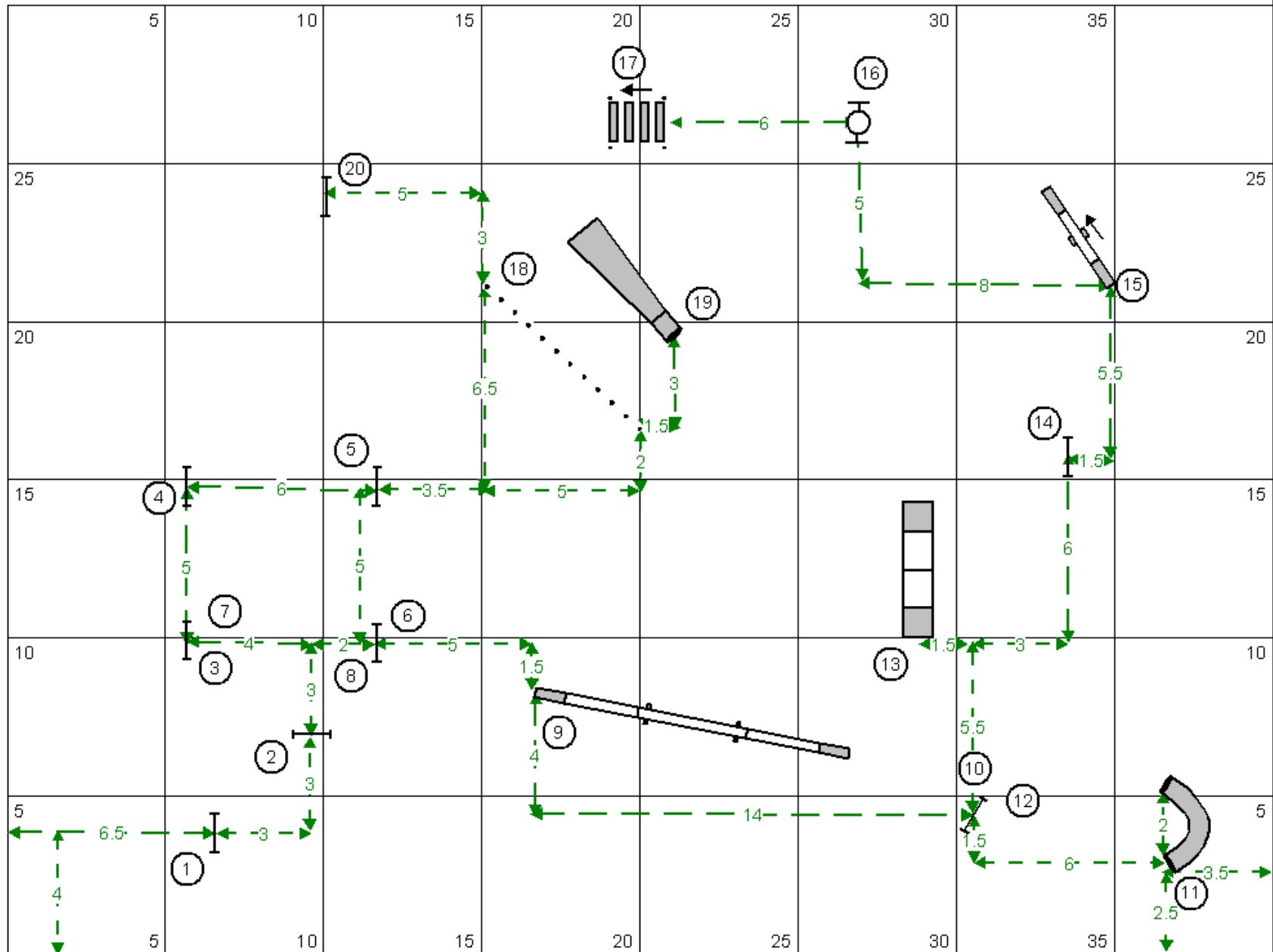

ADX Advanced course 12

CL 162m

SCT = 54 secs

2009 revision

A
s
s
e
m
b
l
y

A
r
e
a

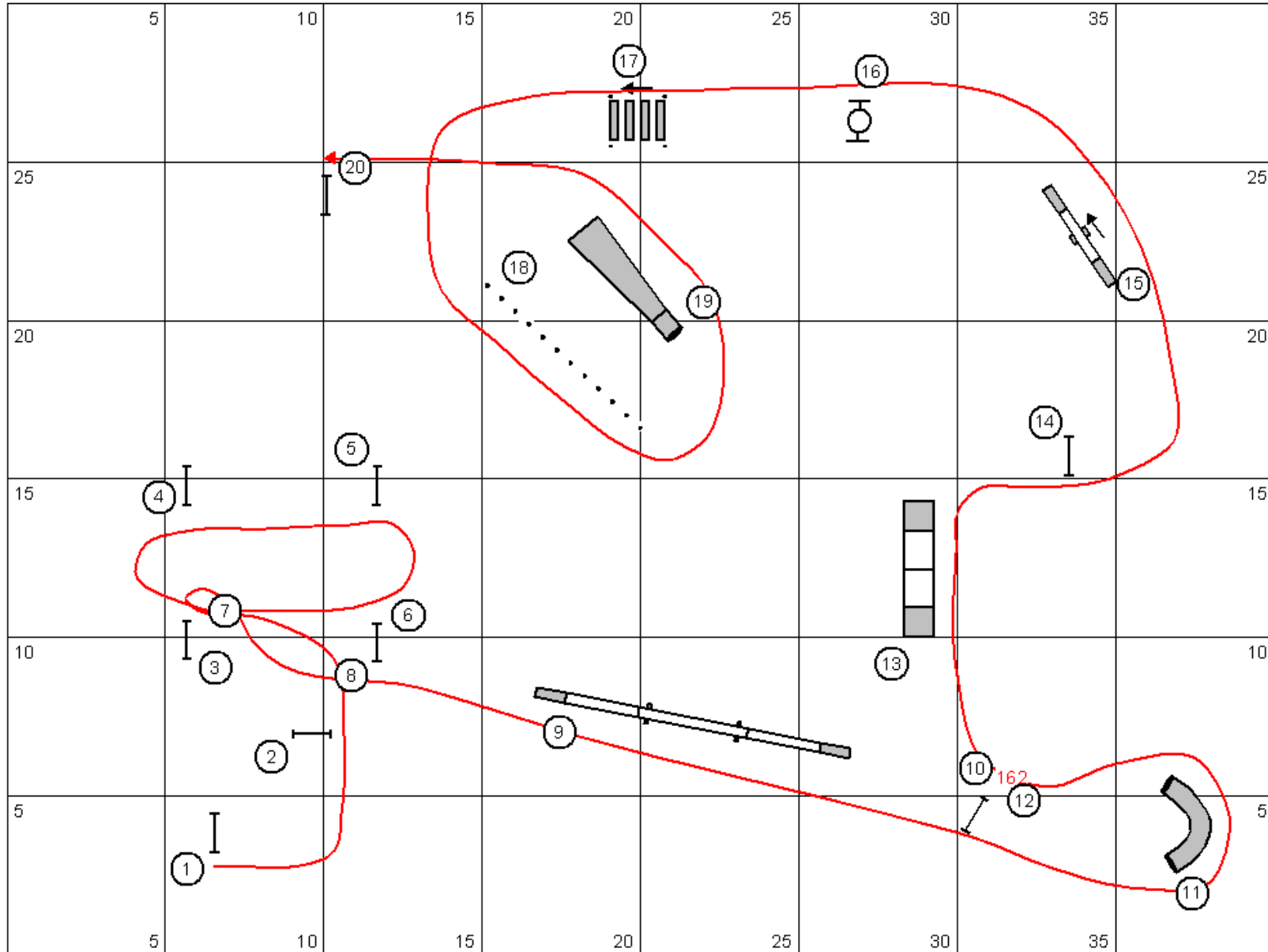

ADX Advanced course number 12 - course measurement guide